

Specifications:
 Rated Voltage : 250V AC/DC
 Rated Current : 2A AC,DC
 Withstand Voltage : 800V AC/minute
 Contact Resistance : 20mΩ(MAX.)
 Insulation Resistance : 1000MΩ(MIN.)
 Temperature Range : -25°C~+85°C
 Material : Nylon66 UL94V-0
 Suitable for HLTC E2502 series terminal

E2502H00-NPX-HF-NK

① ② ③④⑤ ⑥

- ① Series No.
- ② H90 : Side Contact
H00 : Up Contact
- ③ No. of Circuits
- ④ X : Product color(A--Y)
Blank: Natural type
- ⑤ HF : Halogen Free
- ⑥ NK: No Mark
Blank: Mark

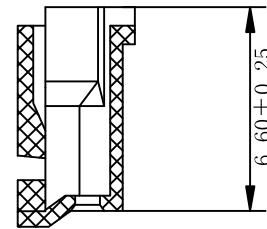
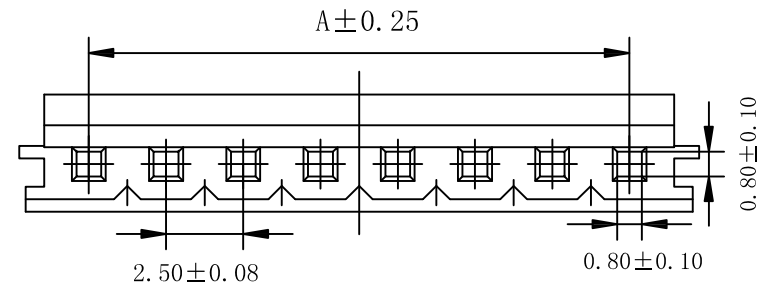

Circuits Part No	Dimensions	
	A	B
2P	2.50	7.00
3P	5.00	9.50
4P	7.50	12.00
5P	10.00	14.50
6P	12.50	17.00
7P	15.00	19.50
8P	17.50	22.00
9P	20.00	24.50
10P	22.50	27.00
11P	25.00	29.50
12P	27.50	32.00
13P	30.00	34.50
14P	32.50	37.00
15P	35.00	39.50
16P	37.50	42.00

				GENERAL TOLERANCE		UNIT: mm		DATE		TITLE:		
				.X ± 0.35		X° ± 1°		DRAWN: 张自豪 2013.11.19		EH2.50 Housing		
				.XX ± 0.25		.X° ±		CHECKED:		PROJECT		
				.XXX ± 0.05		.XX° ±		APPROVED: 张彬彬 2013.11.20		SCALE: N/A		PART NO. E2502H00-NPX-HF-XX
LTR NAME DATE VERISION RECORD				.XXX ± 0.05		.XX° ±		A1 SHEET: 1/1		DRAWING NO. E2502H		

东莞市宏欣蓝电子有限公司

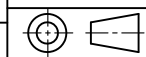

Specifications:

Rated Voltage : 250V AC/DC
 Rated Current : 2A AC,DC
 Withstand Voltage : 1000V AC/minute
 Contact Resistance : 20mΩ(MAX.)
 Insulation Resistance : 1000MΩ(MIN.)
 Temperature Range : -25°C~+85°C
 Suitable E2502 Series Housing

E2502 I 0 P-XX-XX

① ②③④⑤⑥

- ① Series No.
- ② T: Terminal
- ③ 9 : Side Contact
0 : Up Contact
- ④ P : Phosphor Bronze
- ⑤ 2E : Tin-plated
- ⑥ NK : No Mark
Blank : Mark

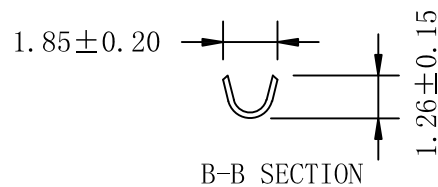
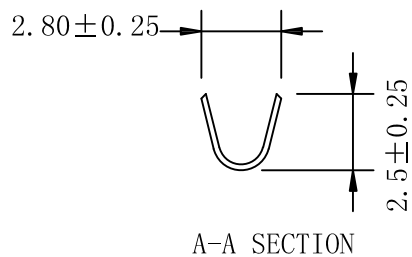
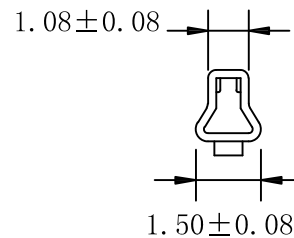
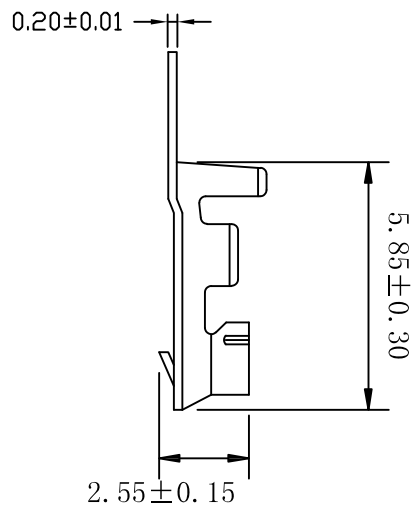
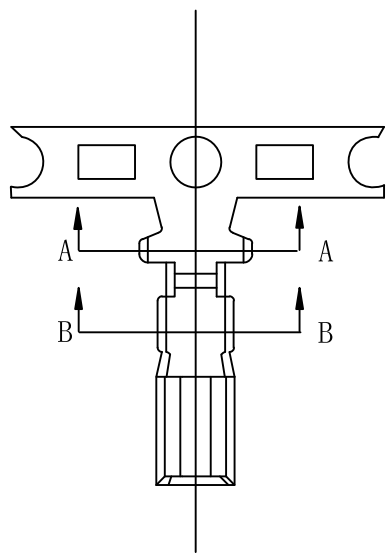

Specifications & Ordering Information:

Part No.	Material	Wire Range	Finish	Qty/Reel
E2502TOP-2-NK	Phosphor Bronze	AWG #22-28	Tin-plated先镀后冲	10000PCS
E2502TOP-2E-NK	Phosphor Bronze	AWG #22~28	Tin-plated先冲后镀	10000PCS

				GENERAL TOLERANCE		UNIT: mm		DATE		TITLE: EH2.50 Terminal			东莞市宏欣蓝电子有限公司										
		.X±0.15		X°±1°		DRAWN: 张自豪		2013.10.30															
		.XX±0.10		.X°±		CHECKED:				VER.		SCALE: N/A		PROJECT		PART NO.		E2502TOP-2E-NK					
LTR		NAME		DATE		VERSION RECORD		.XXX±0.05		.XX°±		APPROVED: 张彬彬		2013.10.30		A1		SHEET: 1/1		DRAWING NO.		E2502T	